

EDITION #14
JANVIER 2025 BRUT

TARIF 2025



Gamme COPROTOIT



coprodex

Des solutions !

www.coprodex.pro

Zone du Composite Park - 2 rue du Lavoir 57890 PORCELETTE - Tél : 03 87 29 90 07



NOS COLORIS D'AVANT-TOIT

P
L
A
X
A
G
E

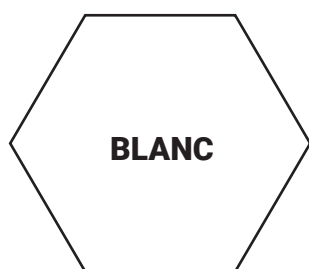

PVC blanc

Planche de rive de 9 mm	5
Planche de rive de 15 mm	6
Lambris de sous face	7



PVC plaxé gris anthracite 7016 veiné

Planche de rive de 9 mm	9
Planche de rive de 15 mm	10
Lambris de sous face	11



PVC plaxé chêne doré

Planche de rive de 9 mm	13
Planche de rive de 15 mm	14
Lambris de sous face	15

T
E
I
N
T
É

M
A
S
S
E



PVC teinté masse gris 7016

Planche de rive de 9 mm	17
Planche de rive de 15 mm	18
Lambris de sous face	19



PVC teinté masse gris 7035

Planche de rive de 9 mm	21
Lambris de sous face	22



PVC teinté masse beige 1015

Planche de rive de 9 mm	25
Lambris de sous face	26

**PVC
BLANC**





PLANCHE DE RIVE DE 9 MM EN PVC BLANC

	Croquis	Coloris	Réf	ℓ	L	Cdt		Tarif BRUT HT	
						Pqt	Pal		
PLANCHES		BLANC	RIVE9175	175 mm	5 ml	10 ml	500 ml	9,48 €/ml	
			RIVE9225	225 mm	5 ml	10 ml	480 ml	13,16 €/ml	
			RIVE9300	300 mm	5 ml	10 ml	360 ml	14,80 €/ml	
			EC935454D	454 mm	5 ml	10 ml	150 ml	23,28 €/ml	
Angle intérieur simple			RIVE9ANGLEINT	300 mm			10 pcs		6,00 €/pc
Angle extérieur simple			RIVE9ANGLEXT	300 mm			10 pcs		6,80 €/pc
Jonction simple			RIVE9JONCTION	300 mm			10 pcs		6,00 €/pc
Clou 40 mm			CL40		40 mm		250 pcs		0,34 €/pc

PLANCHE DE RIVE DE 15 MM EN PVC BLANC

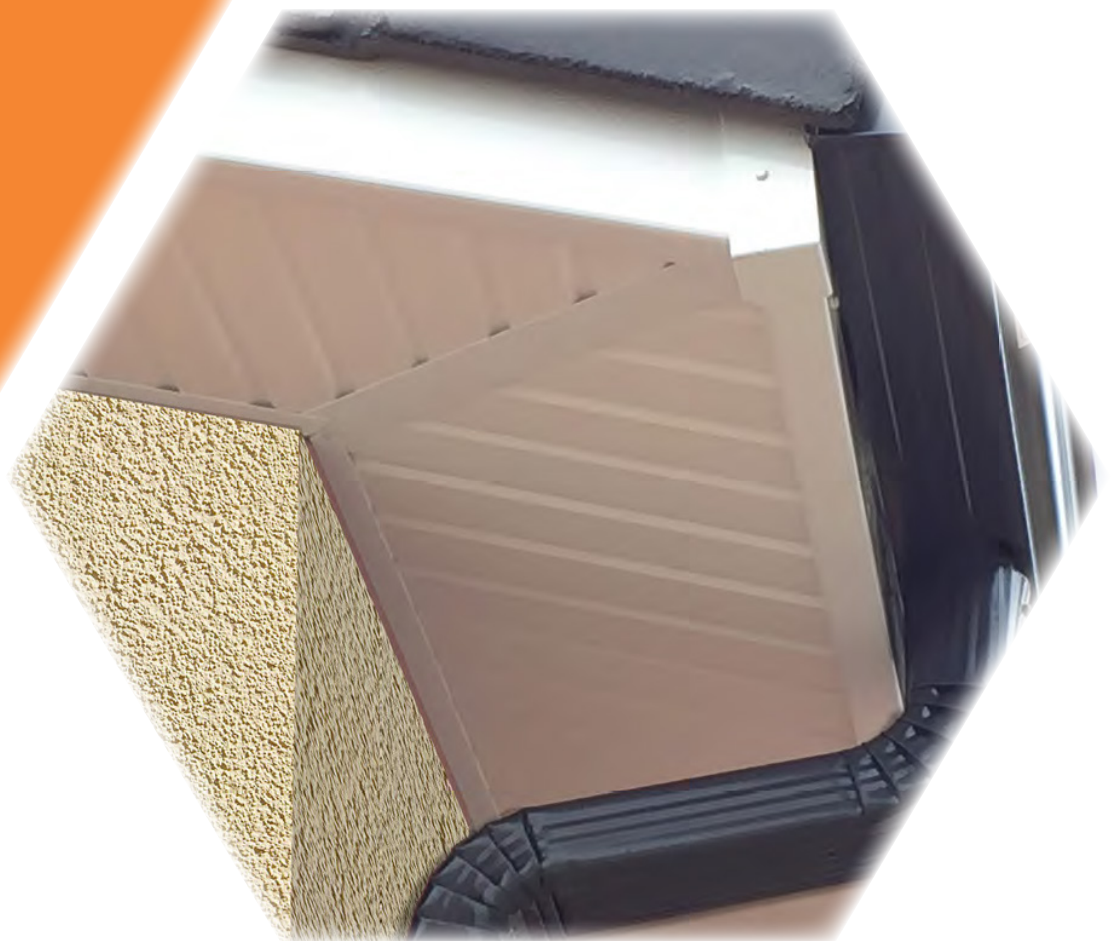
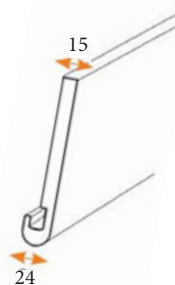

	Croquis	Coloris	Réf	ℓ	L	Cdt		Tarif BRUT HT
						Pqt	Pal	
PLANCHES		BLANC	RIVE15150	150 mm	5 ml	10 ml	700 ml	11,88 €/ml
			RIVE15175	175 mm	5 ml	10 ml	600 ml	12,78 €/ml
			RIVE15200	200 mm	5 ml	10 ml	570 ml	14,84 €/ml
			RIVE15225	225 mm	5 ml	10 ml	480 ml	17,96 €/ml
			RIVE15250	250 mm	5 ml	10 ml	450 ml	19,12 €/ml
			RIVE15404	404 mm	5 ml	10 ml		40,34 €/ml
	Angle intérieur simple			RIVE15ANGLEINT	300 mm			10 pcs
Angle extérieur simple		RIVE15ANGLEXT	300 mm			10 pcs		6,18 €/pc
Jonction simple		RIVE15JONCTION	300 mm			10 pcs		5,04 €/pc
Clou 65 mm		CL65_SW			65 mm	100 pcs		0,68 €/pc

LAMBRIS DE SOUS-FACE EN PVC BLANC

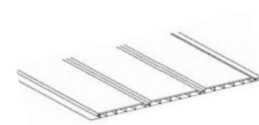

	Croquis	Coloris	Réf	ℓ	L	Ondes	Cdt		Tarif BRUT HT
							Pqt	Pal	
PLANCHETTES		BLANC	L5503	100 mm	6 ml	1	60 ml		3,26 €/ml
			L2603_6	250 mm	6 ml	4	36 ml	1188 ml	5,12 €/ml
			L2603_P3	3 ml	18 ml		666 ml		
			L300_P6	300 mm	6 ml	3	24 ml	1032 ml	5,76 €/ml
			L300_P3		3 ml		12 ml	516 ml	
	L4403		400 mm	5 ml	4	20 ml		8,72 €/ml	
Grille ventilation			GV6010	80 mm	5 ml		25 ml		10,40 €/ml
Grille ventilation 70 mm			GAR70B				pièce		4,52 €/pc
Profilé départ en U			B903.1	22 mm	5 ml		100 ml		2,34 €/ml
Profilé en F			USF_SW/F	32 mm	6 ml		120 ml		3,22 €/ml
Profilé en H		HSF_SW	28 mm	5 ml		100 ml		4,94 €/ml	
H orientable		HO401710	28 mm	6 ml		120 ml		5,16 €/ml	

STABILITE DE LA
TEINTE
GARANTIE
10 ANS

**PVC
PLAXÉ
GRIS
ANTHRACITE
7016
VEINÉ**



PLANCHE DE RIVE DE 9 MM EN PVC PLAXÉ

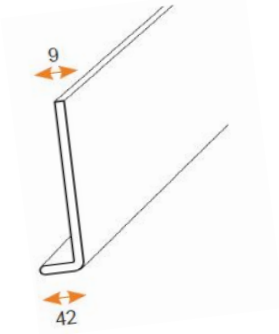

	Croquis	Coloris	Réf	ℓ	L	Cdt	Tarif BRUT HT
						Pqt	
PLANCHE		GRIS ANTHRACITE 7016	RIVES9225_7016	225 mm	5 ml	10 ml	29,50 €/ml
Angle extérieur simple			RIVES9ANGLEXT_7016	300 mm		10 pcs	33,04 €/pc
Jonction simple			RIVES9JONCTION_7016	300 mm		10 pcs	20,68 €/pc
Clou 40 mm		RAL 7016	CL40_7016		40 mm	250 pcs	0,64 €/pc

Les différentes teintes plaxées sont réalisées dans notre atelier en Moselle !



PLANCHE DE RIVE DE 15 MM EN PVC PLAXÉ

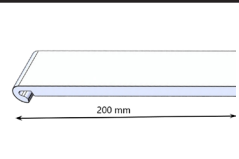
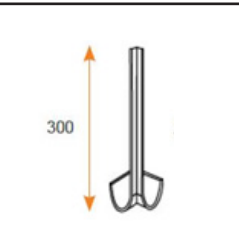
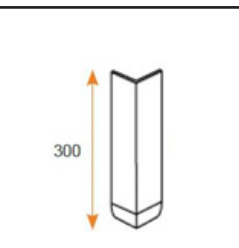
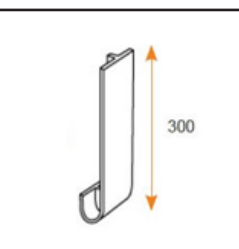
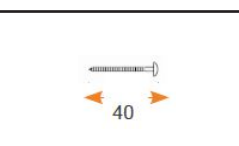

	Croquis	Coloris	Réf	ℓ	L	Cdt	Tarif BRUT HT
						Pqt	
PLANCHE		GRIS ANTHRACITE 7016	RIVES15200P_7016	200 mm	5 ml	10 ml	35,18 €/ml
Angle intérieur simple			RIVES15ANGLEINTP_7016	300 mm		Pièce	41,34 €/pc
Angle extérieur simple			RIVES15ANGLEXTP_7016	300 mm		Pièce	43,60 €/pc
Jonction simple			RIVES15JONCTIONP_7016	300 mm		Pièce	22,42 €/pc
Clou 40 mm		RAL 7016	CL40_7016		40 mm	100 pcs	0,64 €/pc

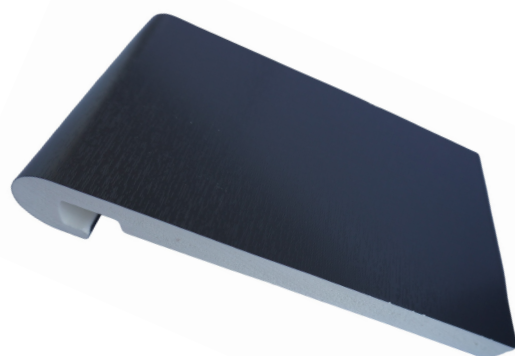

LAMBRIS DE SOUS-FACE EN PVC PLAXÉ

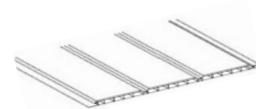

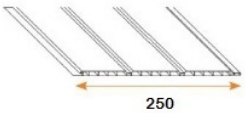
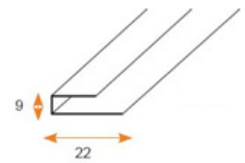
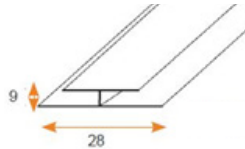
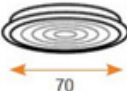
	Croquis	Coloris	Réf	l	L	Ondes	Cdt	Tarif BRUT HT
							Pqt	
PLANCHETTE		GRIS ANTHRACITE 7016	LS2603_SJ_7016	250 mm	6 ml	3	24 ml	22,34 €/ml
Profilé départ en U			BS903_7016	22 mm	5 ml		100 ml	8,80 €/ml
Profilé en H			HSFS_SW_7016	300 mm	5 ml		100 ml	11,34 €/ml
Grille de ventilation 70 mm		NOIR	GAR70_NOIR				Pièce	5,40 €/pc



Autres coloris possibles, n'hésitez pas à nous consulter.

**STABILITE DE LA
TEINTE
GARANTIE
10 ANS**



**PVC
PLAXÉ
CHÊNE DORÉ**







PLANCHE DE RIVE DE 9 MM EN PVC PLAXÉ

	Croquis	Coloris	Réf	l	L	Cdt	Tarif BRUT HT
						Pqt	
PLANCHES		CHENE DORÉ 217.8001	RIVES9175_8001	175 mm	5 ml	10 ml	24,68 €/ml
			RIVES9225_8001	225 mm	5 ml	10 ml	29,50 €/ml
			RIVES9300_8001	300 mm	5 ml	10 ml	46,68 €/ml
Angle extérieur simple			RIVES9ANGLEXT_8001	300 mm		Pièce	33,04 €/pc
Jonction simple			RIVES9JONCTION_8001	300 mm		Pièce	20,68 €/pc
Clou 40 mm			RAL 8003	CLS40_8003		40 mm	250 pcs

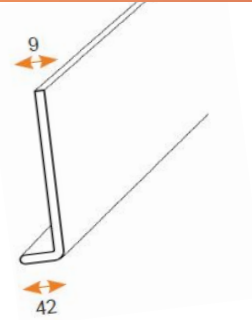
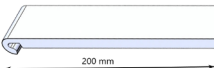
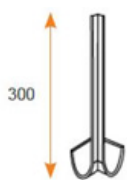
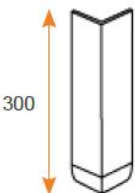
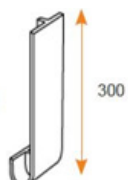

PLANCHE DE RIVE DE 15 MM EN PVC PLAXÉ

	Croquis	Coloris	Réf	ℓ	L	Cdt	Tarif BRUT HT
						Pqt	
PLANCHE		CHENE DORÉ 217.8001	RIVES15200_8001	200 mm	5 ml	10 ml	35,18 €/ml
Angle intérieur simple			RIVES15ANGLINTP_8001	300 mm		Pièce	41,34 €/pc
Angle extérieur simple			RIVES15ANGLEXTP_8001	300 mm		Pièce	43,60 €/pc
Jonction simple			RIVES15JONCTIONP_8001	300 mm		Pièce	22,42 €/pc
Clou 50 mm		RAL 8003	CLS50_8003		50 mm	100 pcs	0,64 €/pc

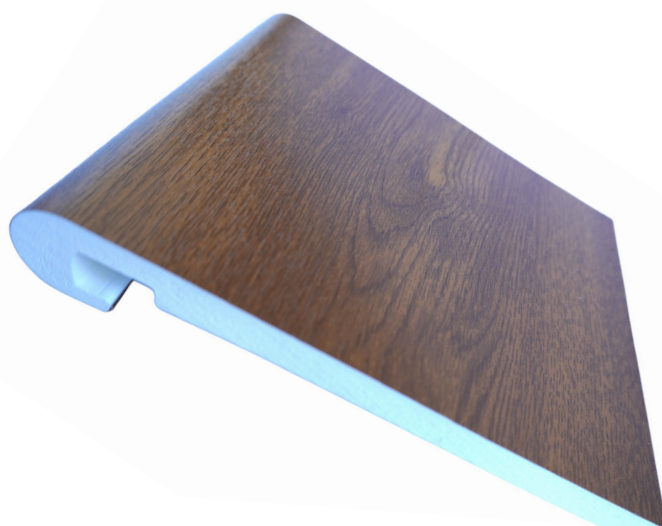

LAMBRIS DE SOUS-FACE EN PVC PLAXÉ

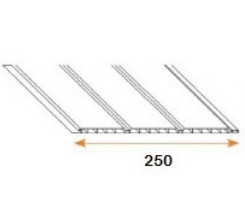
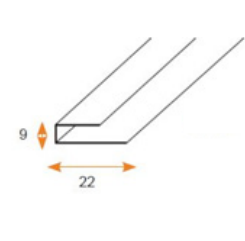
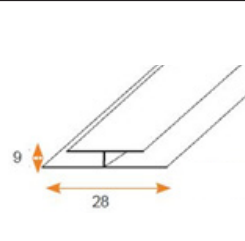
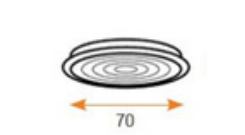

	Croquis	Coloris	Réf	<i>l</i>	L	Ondes	Cdt	Tarif BRUT HT
							Pqt	
PLANCHETTE		CHÊNE DORÉ 217 8001	LS2603_SJ_8001	250 mm	6 ml	3	24 ml	22,34 €/ml
Profilé départ en U			BS903_8001	22 mm	5 ml		100 ml	8,80 €/ml
Profilé en H			HSFS_SW_8001	300 mm	5 ml		100 ml	11,34 €/ml
Grille de ventilation 70 mm		RAL 8003	GAR70_8003				Pièce	4,70 €/pc



Autres coloris possibles, n'hésitez pas à nous consulter.

**PVC
TEINTÉ
MASSE
GRIS
ANTHRACITE
7016**





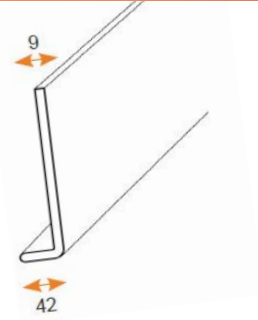

**PLANCHE DE RIVE DE 9 MM EN PVC
TEINTÉ MASSE**



	Croquis	Coloris	Réf	ℓ	L	Cdt	Tarif BRUT HT
						Pqt	
PLANCHE	 225	7016	RIVE9225_7016	225 mm	5 ml	10 ml	18,10 €/ml
Angle intérieur simple	 300		AGIN03_7016	300 mm		10 Pcs	10,90 €/pc
Angle extérieur simple	 300		AGET03_7016	300 mm		10 Pcs	10,90 €/pc
Jonction simple	 300		AGJB03_7016	300 mm		10 Pcs	6,64 €/pc
Clou 40 mm	 40		CL40_7016		40 mm	250 pcs	0,64 €/pc

PLANCHE DE RIVE DE 15 MM EN PVC TEINTE MASSE



	Croquis	Coloris	Réf	l	L	Cdt	Tarif
						Pqt	BRUT HT
PLANCHE		7016	RIVE15200_7016	200 mm	5 ml	10 ml	27,76 €/ml
Angle intérieur simple			AGIN300_7016	300 mm		10 pcs	10,90 €/pc
Angle extérieur double			AGET600_7016	600 mm		10 pcs	17,46 €/pc
Jonction double			J600_7016	600 mm		10 pcs	16,60 €/pc
Clou 40 mm			CL40_7016		40 mm	250 pcs	0,64 €/pc



LAMBRIS DE SOUS-FACE EN PVC TEINTE MASSE

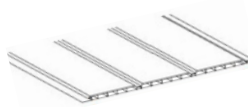

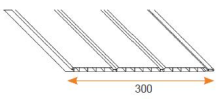
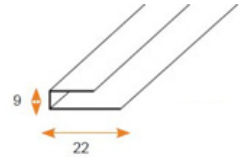
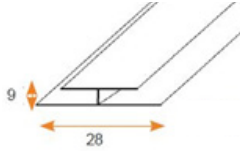
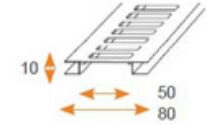
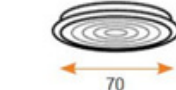
	Croquis	Coloris	Réf	ℓ	L	Ondes	Cdt	Tarif BRUT HT
							Pqt	
PLANCHETTE		7016	L300_7016	300 mm	5 ml	3	30 ml	7,80 €/ml
Profilé départ en U			B903_7016	22 mm	5 ml		100 ml	2,72 €/ml
Profilé en H			HSF_SW_7016	28 mm	5 ml		100 ml	4,94 €/ml
Grille de ventilation			GV6010_7016	80 mm	5 ml		25 ml	8,60 €/ml
Grille de ventilation 70 mm		NOIR	GAR70_NOIR				Pièce	5,40 €/pc

**PVC
TEINTÉ
MASSE
GRIS
7035**



**PLANCHE DE RIVE DE 9 MM EN PVC
TEINTÉ MASSE**

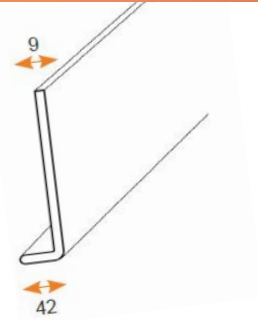

	Croquis	Coloris	Réf	ℓ	L	Cdt	Tarif BRUT HT
						Pqt	
PLANCHE		7035	EC935200_7035	200 mm	5 ml	10 ml	13,84 €/ml
Angle extérieur simple			AGET300_7035	300 mm		10 Pcs	11,68 €/pc
Jonction simple			J300_7035	300 mm		10 Pcs	9,50 €/pc
Clou 40 mm			CL40_INOX		40 mm	250 pcs	0,34 €/pc



LAMBRIS DE SOUS-FACE EN PVC TEINTE MASSE

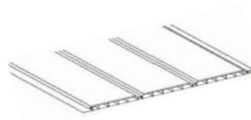

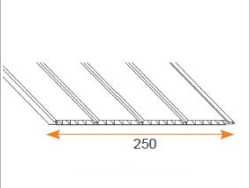
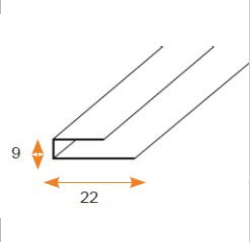
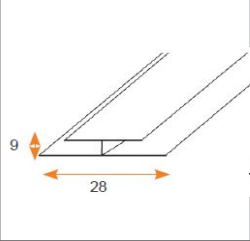
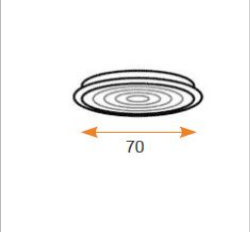
	Croquis	Coloris	Réf	<i>l</i>	L	Ondes	Cdt	Tarif BRUT HT
							Pqt	
PLANCHETTE		7035	L3303_7035	250 mm	6 ml	4	36 ml	5,80 €/ml
Profilé départ en U			B903_7035	22 mm	6 ml		120 ml	2,72 €/ml
Profilé en H			HSF_SW_7035	28 mm	6 ml		120 ml	2,66 €/ml
Grille de ventilation 70 mm		NOIR	GAR70_NOIR				Pièce	5,40 €/pc



**PVC
TEINTÉ
MASSE
BEIGE
1015**



**PLANCHE DE RIVE DE 9 MM EN PVC
TEINTÉ MASSE**

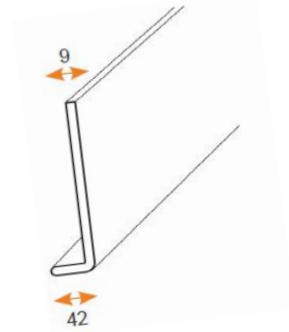

	Croquis	Coloris	Réf	ℓ	L	Cdt	Tarif BRUT HT
						Pqt	
PLANCHE		1015	EC1042200_SABL	200 mm	5 ml	10 ml	13,84 €/ml
Angle extérieur simple			AGET03_SABL	300 mm		10 Pcs	11,68 €/pc
Jonction simple			AGJB03_SABL	300 mm		10 Pcs	9,98 €/pc
Clou 40 mm			CL40_SABL		40 mm	250 pcs	0,68 €/pc



LAMBRIS DE SOUS-FACE EN PVC TEINTE MASSE

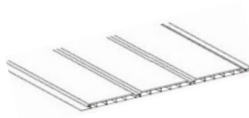

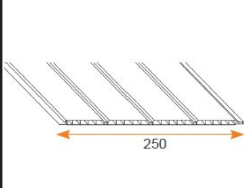
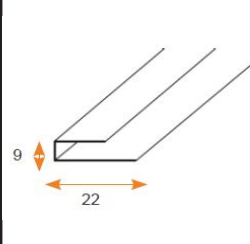
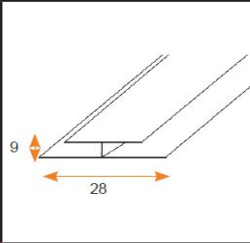
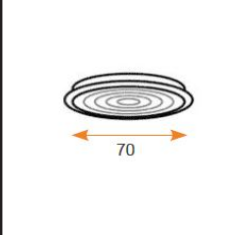
	Croquis	Coloris	Réf	ℓ	L	Ondes	Cdt	Tarif BRUT HT
							Pqt	
PLANCHETTE		1015	L3303_SABL	250 mm	6 ml	4	36 ml	5,80 €/ml
Profilé départ en U			B903_SABL	22 mm	6 ml		120 ml	2,72 €/ml
Profilé en H			H1003_SABL	28 mm	6 ml		120 ml	2,66 €/ml
Grille de ventilation 70 mm			GAR70_SABL				Pièce	6,28 €/pc

Exemples de mises en oeuvre

Départ en F
Planchette de sous-face et rive de 9 mm

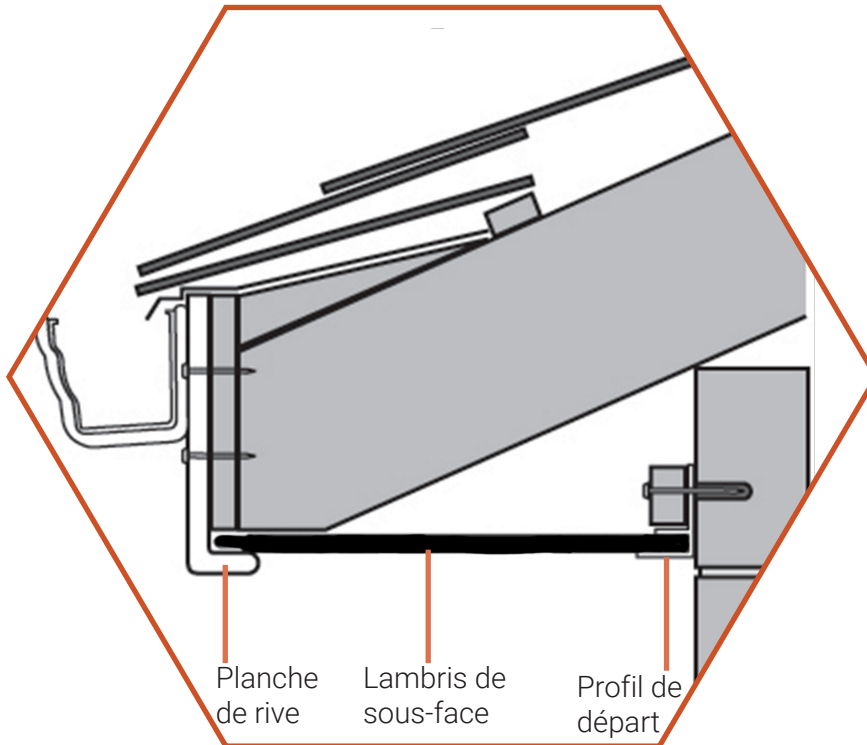

Angle extérieur

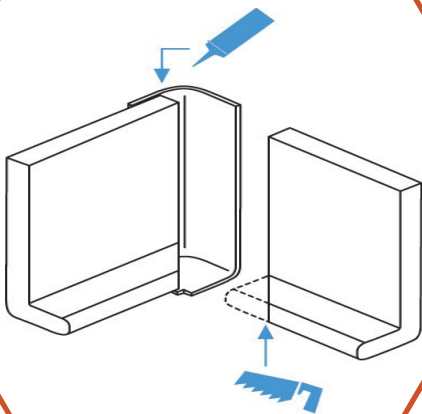

Jonction

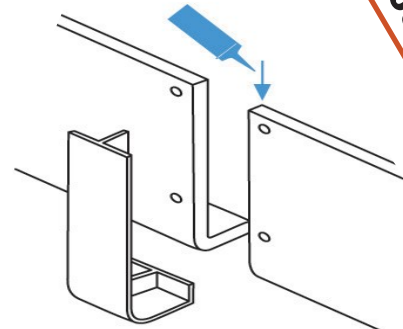

*N'hésitez pas
à consulter
nos accessoires
dans notre
catalogue général*

www.coprodex.pro



Soucieux de l'environnement,
Coprodex met en place
l'éco-contribution avec  valobat
Celle-ci sera facturée en complément des
prix affichés

coprodex

Des solutions !

HORAIRES ACCUEIL COMMERCIAL

- > **Du lundi au jeudi :**
de 7h30 à 12h00 et de 13h00 à 18h00
- > **Le vendredi :**
de 7h30 à 12h00 et de 13h00 à 17h00

NOUS CONTACTER

- ✉ Coprodex - Zone du Composite Park
2 rue du Lavoir 57890 PORCELETTE
- ☎ +33 (0) 3 87 29 90 07
- @ coprodex@coprodex.com
- 🌐 www.coprodex.pro